

# BR600T\_90 IntelliBarrier Folding Arm Barrier Gate



Date: 26 May 2017

## General Description

BR600T\_90 support 90° folding arm to accommodate low height ceiling such as basement parking and multi level parking. BR600T\_90 design is optimized to be highly affordable for commercial, residential and industrial application.

MAG intelligent barrier uses digital electronic motor counter to ensure that the arm opens and closes perfectly EVERY TIME. Built in optical sensor as redundant safety ensures arm never fail. Electronic parts is not subject to wear & tear and therefore is safer and maintenance free.



IS YOUR FIRST STEP  
IN SECURITY

**Automate and secure  
your entrance with style**



## Application

Suitable for indoor parking area at airport, shopping mall, warehouse, hotel, factories, condominium, car rental companies, etc. It can also be customized to be used together with any auto-pay ticketing parking or access control system.

## Features

**Intelligent.** Advanced smart motor control system is combined with unique lever design to achieve swift arm movement that reduces bouncing at end position.

**DSP Dual Spring** mechanism to achieve two times smoother arm motion. Combination of different tension force reduced vibration as the arm stop. Well balanced arm weight reduces the possibility of broken spring thus reducing down time.

**BlueSpeed motor** uses lowest possible rotation speed (RPM) with our force rotation ratio technology to achieve high speed opening. This reduces mechanical wear and effectively eliminates any maintenance servicing on the motor.

**DSD Dual Sensor Detection** to achieve double safety. Innovative design monitors current spike and motor rotation simultaneously to auto-reverse arm if blocked by obstacle. This is an important safety feature to prevent further damage in the event when arm hit car or pedestrian.

**Improved air ventilation.** New fan design located at top instead of sideways. This allowed cool air enter from bottom and exit from top to achieve more efficient cooling this enabling BR600T series to support higher flow of traffic.

**Improved NLSV2 design.** NLS V2 is using magnet sensor instead of optical sensor. Optical sensor is subjected to interference from ambient light level. New NLS design removed all blind spot area to achieve perfect opening and closing consistently.

**Safe.** Arm will auto-reverse when hitting an obstacle during closing. Photo beam can be added to auto-reverse the arm ahead of time before hitting approaching vehicle or human. Arm will swing out during direct collision from front avoid arm frequently broken (only available in BR618T and BR630T).

Traffic light (red & green) can be added to indicate permission to pass through and further enhance safety usage. Built-in MCB to protect against any electric hazard.

**Heavy Duty.** Enhanced NLS design eliminates the use of mechanical limit switch thus reducing mechanical wear and tear. Innovative counter weight spring design avoids possibility of motor over-stressed and break due to high volume continuous open/close cycle. All these allow BR600T to work harder and work longer for you.

**User Friendly.** In the event of power failure, arm can be easily lifted up by insert a key from outside to unlock the clutch. There is no need to open up entire casing to avoid any vandalism attempt of internal parts.

**Easy maintenance.** Epoxy powder paint will keep the unit looking clean and new for years. Damaged barrier arm can be replaced easily. AC based motor is stronger and maintenance free (no need to change carbon).

## Technical specification

### Mechanical unit

Consist of the drive motor, speed reduction gear box and casing. Control panel is mounted into mechanical unit casing as a complete system that drives the arm movement. Casing is made with electroplated mild steel and finished with epoxy powder paint. The top cover and door on casing is cam locked (requires key) to avoid tampering with the internal system. The following is the parameter for complete system:

Description	Parameter
Mechanical temperature	-40° to 75 C
Electrical temperature	-10° to 75 C
Power supply input	220V ± 10% AC, 50/60Hz
Power consumption	80 watt - 1.25A @240V
Relative humidity	< 90 %
Arm speed	1.8 second, 3 second
Internal lubrication	Grease
Max starting torque	Max torque : 1 second : 1.4±0.2 N.M   3 / 6 second : 2.1 ± 0.1 N.M
AC rotation speed	AC rotation speed :1 second : 900 ± 50 RPM   3/6 second : 460 ± 40 RPM

Built in spring mechanism to counter balance arm's weight allow for effortless motor drive and longer mechanical life span.

### Control panel

Consist of advance intelligent microprocessor based board and transformer housed in a weather resistant plastic casing. It controls the operation of the barrier system.



#### Function:

- Support 2 type of speed - 1.8 , 3 second
- Support separate push button for opening , closing and stop
- Support motor encoder sensor
- Support traffic light (red - green) output AC230
- Optical slot sensor to control up and down limit

Casing is made from weather proof ABS plastic.  
Casing dimension: 211mm x 95mm x 118mm

### Barrier arm

Arm is made of octagon aluminum hollow. There are standard lengths available: 4m. Other customized length is also available upon request. Red reflective adhesive is put onto the arm alternately for better visual during night time.

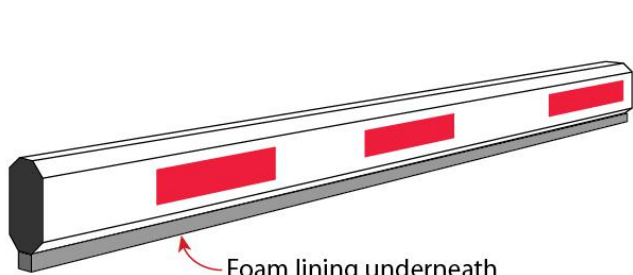

Foam lining underneath barrier arm to reduce dent damage in the event top down collision with vehicle.

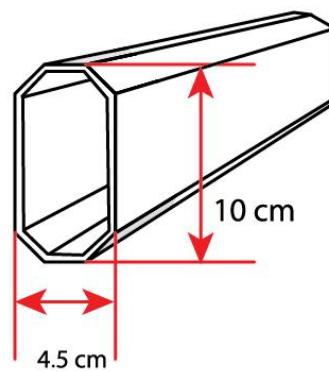

Folding arm and 6 meter big octagon arm

### Typical installation diagram - with access control system

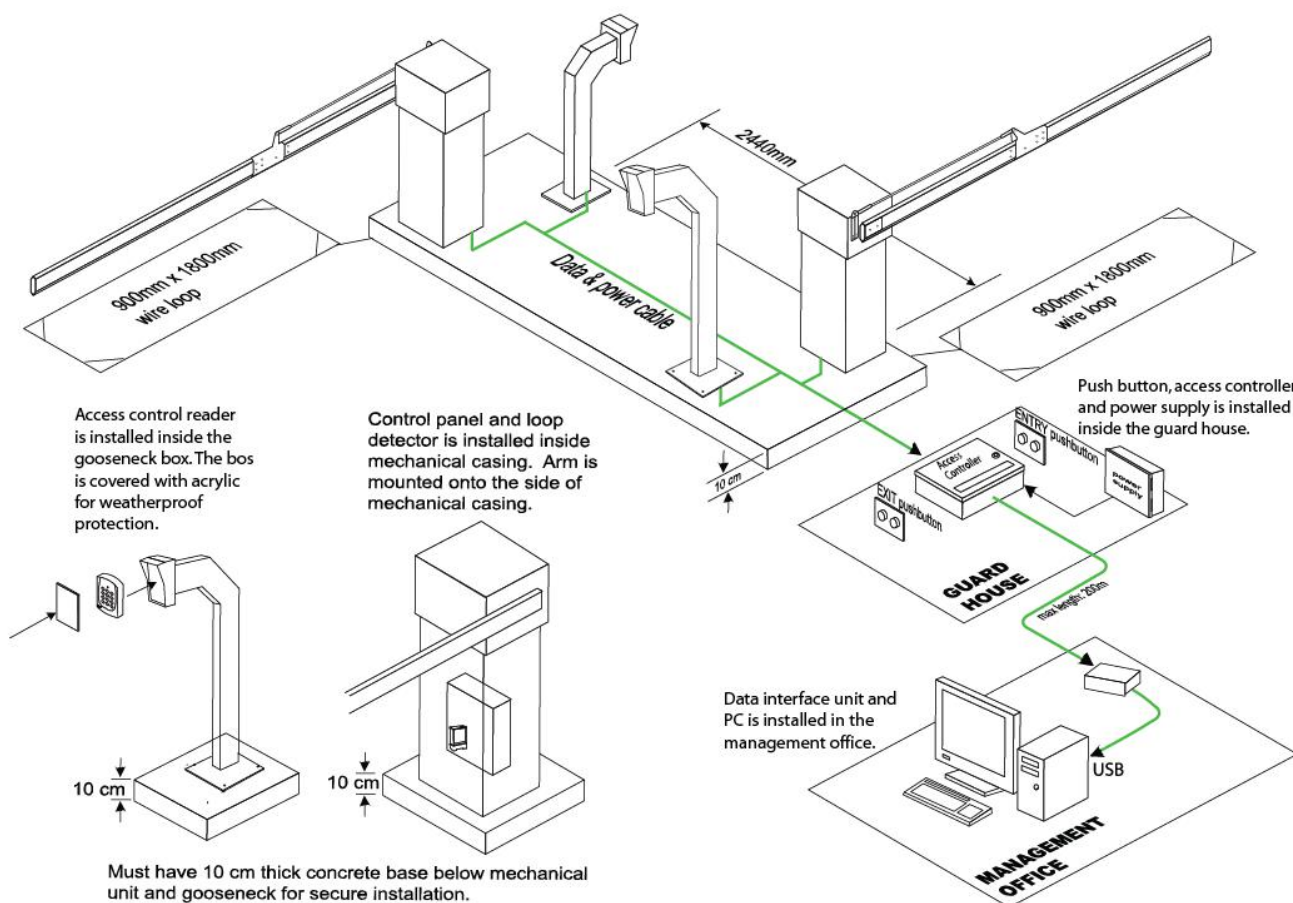

*\*\*Diagram is for illustration only and does NOT reflect actual installation. Actual installation dimension varies depending on site.*

## Dimension drawing

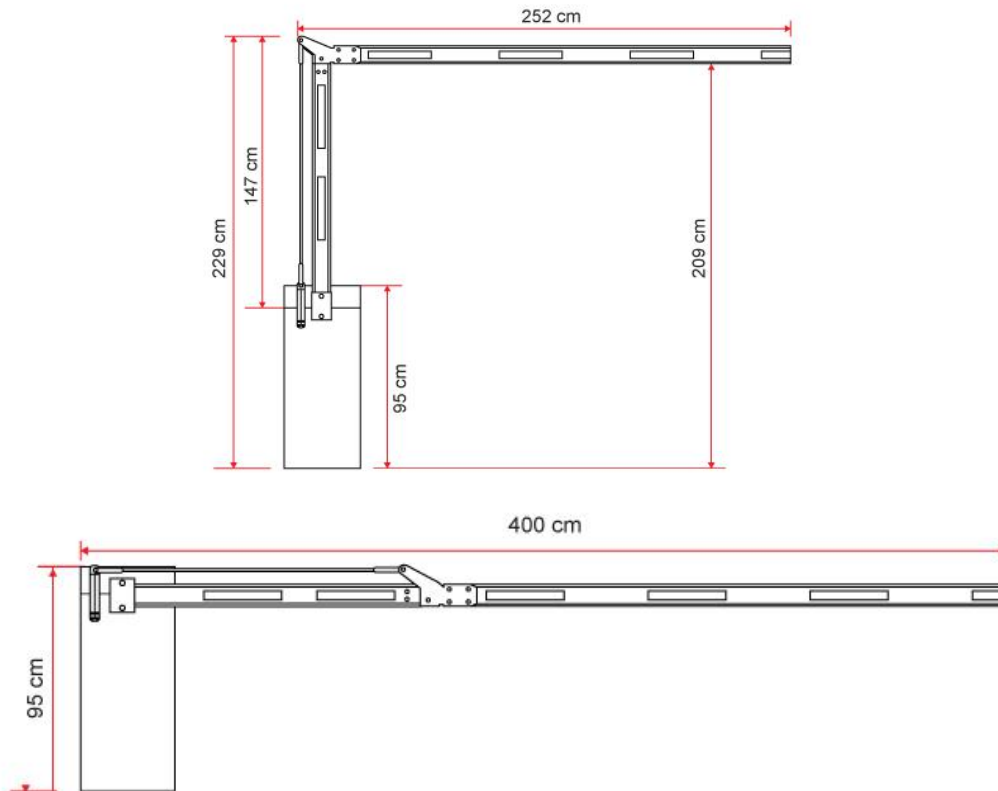

## Ordering information

Ordering code:

Model No	Description
BR618TL_90	Left Side Arm
BR618TR_90	Right Side Arm
BR630TL_90	Left Side Arm
BR630TR_90	Right Side Arm

## Packaging information

Standard color body is gray, top cover is dark gray in color. A complete system consists of:

- 1 pcs Standard AC 230 Motor
- 1 pcs Control panel and MCB switch
- 1 set Aluminum Arm
- 2 pcs U bracket for base mounting
- 4 pcs Raw bolt screw

The following is the approximate weight information of major components to help estimate shipping cost.

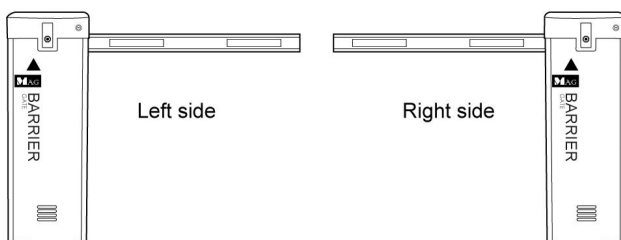

Items	Weight
Mechanical unit and control panel	75 kg
Gooseneck	9 kg
4 meter folding arm	8 kg

## Optional accessories

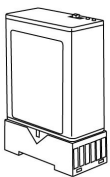

**MAG BRD01**  
Single channel loop detector. Detect presence of vehicle.

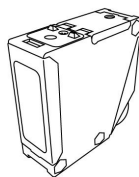

**Panasonic EQ501**  
Safety IR beam sensor. Detect obstacle in barrier path and auto reverse barrier arm for extra safety

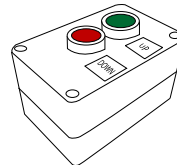

**BR\_PB2**  
Heavy duty push button for manual open and close.

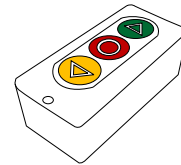

**BR\_PB3**  
Light usage push button for manual open, stop and close.

Authorized dealer:

**Disclaimers**

Applications that are described herein for any of these products are for illustrative purposes only. Drawing does not necessary reflect exact assembly/installation. MAG makes no representation or warranty that such applications will be suitable for the specified use without further testing or modification.

MAG reserves the right to make changes, without notice, in the products, including circuits, standard cells, and/or software, described or contained herein in order to improve design and/or performance. MAG assumes no responsibility or liability for the use of any of these products, conveys no license or title under any patent, copyright, or masks work right to these products, and makes no representations or warranties that these products are free from patent, copyright, or mask work right infringement, unless otherwise specified.

© MAG. All rights reserved. Date released: 7 April 2017