

LNO-6020R

2M H.264 IR Bullet Camera

Network



FC | UL LISTED | CE | ENEC

Key Features

- Max. 2megapixel (1920 x 1080) resolution
- Built-in 4mm fixed lens
- Max. 30fps@all resolutions (H.264)
- H.264, MJPEG codec supported, Multiple streaming
- Day & Night (ICR), WDR (120dB)
- Tampering, Motion detection
- microSD/SDHC/SDXC memory slot (Max. 32GB), PoE
- Hallway view, WiseStreamII support
- IR viewable length 30m
- IP66 support

※ Available in select regions

Video	
Imaging Device	1/2.9" 2MP CMOS
Resolution	1920x1080, 1280x1024, 1280x960, 1280x720, 1024x768, 800x600, 800x448, 720x576, 640x480, 640x360, 320x240
Max. Framerate	H.264: Max. 30fps/25fps(60Hz/50Hz) MJPEG : Max. 1fps at 1920x1080, 1280x1024, 1280x720, 1024x768, Max. 15fps at other resolution
Min. Illumination	Color: 0.18Lux(F2.0, 1/30sec) BW : 0Lux (IR LED on)
Lens	
Focal Length (Zoom Ratio)	4.0mm fixed focal
Max. Aperture Ratio	F2.0
Angular Field of View	H: 80.0° / V: 43.0° / D: 94.0°
Min. Object Distance	0.5m(1.64ft)
Focus Control	Fixed
Operational	
Camera Title	Displayed up to 15 characters
Day & Night	Auto(ICR)
Backlight Compensation	BLC, WDR, SDDR
Wide Dynamic Range	120dB
Digital Noise Reduction	SSNR
Motion Detection	4ea, rectangler zones
Privacy Masking	6ea, rectangular zones
Gain Control	Support
White Balance	ATW / AWC / Manual / Indoor / Outdoor
LDC	Low / Middle / High
Electronic Shutter Speed	Minimum / Maximum / Anti flicker
Video Rotation	Flip, Mirror, Hallway view(90°/270°)
Analytics	Motion detection, Tampering
Alarm Triggers	Analytics
Alarm Events	File upload via FTP and e-mail Notification via e-mail SD/SDHC recording at event triggers
IR Viewable Length	30m(98.43ft)
Network	
Ethernet	RJ-45(10/100BASE-T)
Video Compression	H.264: Main/Baseline/High, MJPEG
Smart Codec	WiseStream II
Bitrate Control	H.264: CBR or VBR MJPEG: VBR

Streaming	Unicast(6 users) / Multicast Multiple streaming (Up to 3 profiles)
Protocol	IPv4, IPv6, TCP/IP, UDP/IP, RTP(UDP), RTP(TCP), RTCP, RTSP, NTP, HTTP, HTTPS, SSL/TLS, DHCP, FTP, SMTP, ICMP, IGMP, SNMPv1/v2c/v3(MIB-2), ARP, DNS, DDNS, QoS, UPnP, Bonjour
Security	HTTPS(SSL) Login Authentication Digest Login Authentication IP Address Filtering User access log 802.1X Authentication(EAP-TLS, EAP-LEAP)
Application Programming Interface	ONVIF Profile S/G SUNAPI(HTTP API)

General

Web Viewer	Supported OS: Windows 7, 8.1, 10, Mac OS X 10.10, 10.11, 10.12 Recommended Browser: Google Chrome Supported Browser: MS Explore11, MS Edge, Mozilla Firefox(Window 64bit only), Apple Safari(Mac OS X only)
Edge Storage	Micro SD/SDHC 1slot 32GB
Memory	256MB RAM, 256MB Flash

Environmental & Electrical

Operating Temperature / Humidity	-30°C ~ +55°C(-22°F ~ +131°F) / Less than 90% RH * Start up should be done at above -20°C(-4°F)
Storage Temperature / Humidity	-30°C ~ +60°C(-22°F ~ +131°F) / Less than 90% RH
Certification	IP66
Input Voltage	PoE(IEEE802.3af, Class3)
Power Consumption	PoE: Max 6.50W

Mechanical

Color / Material	Dark grey / Plastic
Product Dimensions / Weight	Ø58.6x182.0mm(Ø2.31x7.17"), 240g(0.53 lb)

- The latest product information / specification can be found at hanwha-security.com
- Design and specifications are subject to change without notice.
- Wisenet is the proprietary brand of Hanwha Techwin, formerly known as Samsung Techwin.

NO	PART NAME	CODE NO.	MATERIAL	Q'TY	REMARK
1	-	-	-	1	-

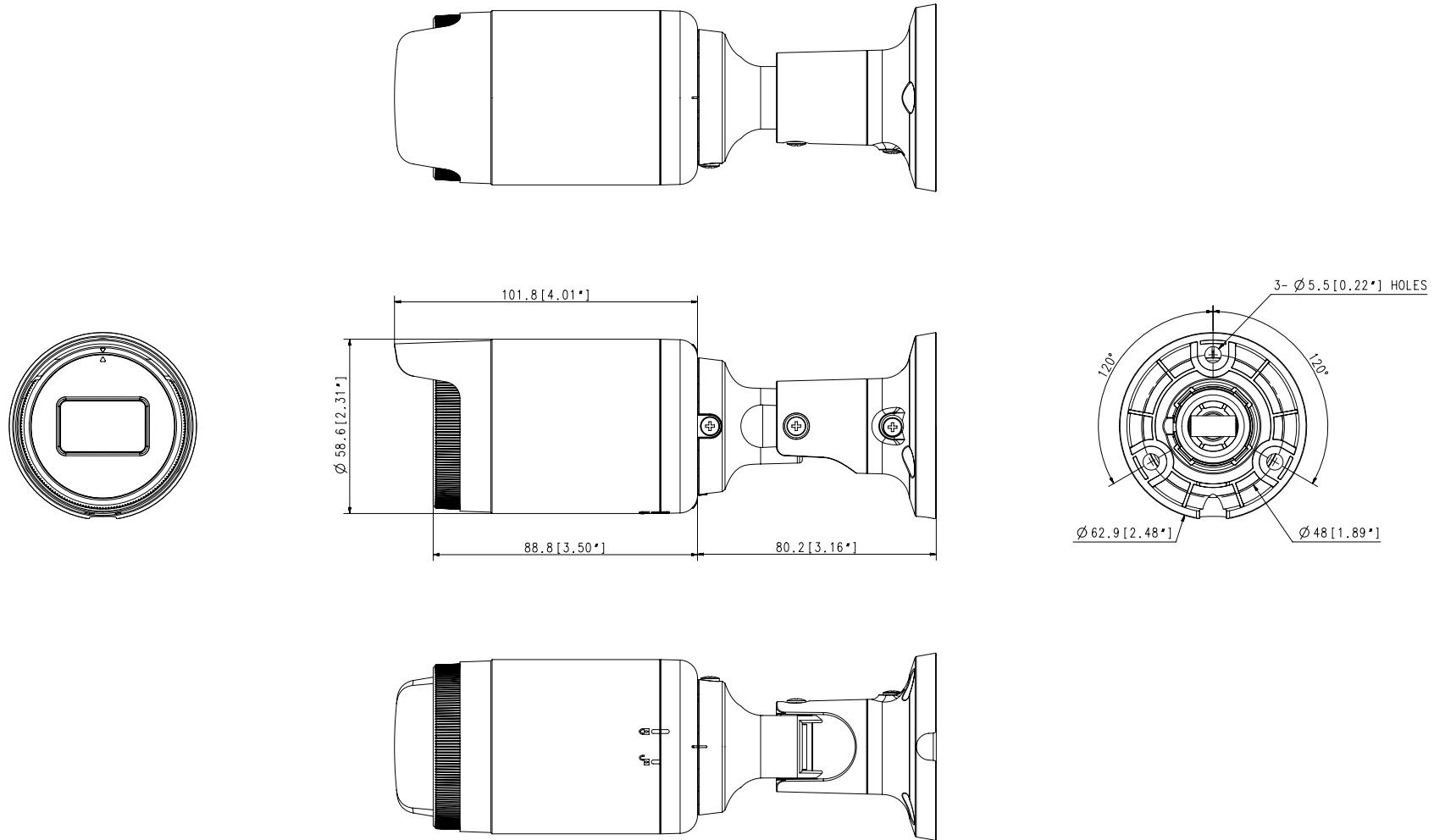

CHANGE

UNIT	mm	DESIGN	CHECK	APPROVAL	PART NAME	APPEARANCE
SCALE	1/1	HTW	-	-	MODEL NAME	LNO-6010R/6020R/6030R
		17.11.16	-	-	CODE NO.	-
HANWHA TECHWIN						