

# **SOYAL**

## **Network Proximity Access Control System**

### **701 Server**

### **User Manual**

**Ver. 6.20**

**Jan. 25 2004**

# Table of Contents

	Page
1. Introduction	2
Brief introduction of 701 Server and 701 Client	2
1.1 Menu Bar content	2
1.2 Tool Bar content	2
2. Installation	3
3. Operator Management	5
4. Access Level	5
5. LAN Base & Communication Port Setting	6
5.1 How to be on-line between PC and controllers	6
5.2 Communication port setting via com port or TCP/IP	8
5.3 Communication port setting via Modem	9
5.4 Communication port setting via Server Computer	10
6. Lan Chart	12
7. 701E / 716E PARAMETER	12
7.1 Program on-line reader location	12
7.2 How to enter 701E / 716E parameter setting	13
7.3 On-line Reader	13
7.4 Door Number	16
7.5 Duress Code & Force On/Off Code	17
7.6 Reader Relay v.s. 701E Reays	17
7.7 Time-scheduled Output	18
7.8 DI Input v.s. Relay Output Connection	19
7.9 Parking Space	20
8. 821E / 829E Parameter Setting	21
8.1 Program AR-829E/821EF single-door networking controller location	21
8.2 How to enter AR-829E/821EF parameter setting	21
8.3 How to assign Door Number	21
8.4 How to change Node ID by software	22
8.5 How to change master code by software	22
8.6 Time schedule for Door Relay, Wait Delay (Door Close Tm), Alarm Delay, Alarm Relay	22
8.7 How to change standby mode's title on the LCD display	23
8.8 Duress Code	23
8.9 Daily Time Schedule	23
8.10 Other function	24
9. Time Attendance	27
10. Message Import	28
11. Change the picture that enter 701 Server	30
12. Remarks columns	31
AR-716EV2/716Ei & 721H/727H System Setting Table	31
AR-829E /821EF System Setting Table	31

# 1. Introduction

## 1.1 Brief introduction of 701 Server and 701 Client

**701 Server** and **701 Client** are multiple language and true 32-bit software package that runs under Windows 98, 2000, NT and XP, and is for all SOYAL Proximity Access Control **off-line networking systems**.

The **701 Server** is a dedicated software program that provides with mainly communication port selection, data collection, system components physical connection, and all the controller's parameter settings. With the TCP/IP remote access ability, this feature can support remote location configuration and data collection. Through the NetBEUI protocol and Local Area Network, the Server Computer and Client Computers can be spread throughout many offices and buildings; authorized users can monitor the system by using either Server Computer or Client Computer in their offices.

The **701 Client** is a software program that dedicates the software tools for Door Access Control, Time & Attendance, Payroll, Elevator Control, Car Park Control, Access Records Reports, Time & Attendance Daily/Monthly Reports, Projects Management and Operators Authority Level Control. System also provides with the ability to import bitmap files for photos.

## 1.2 Menu Bar content

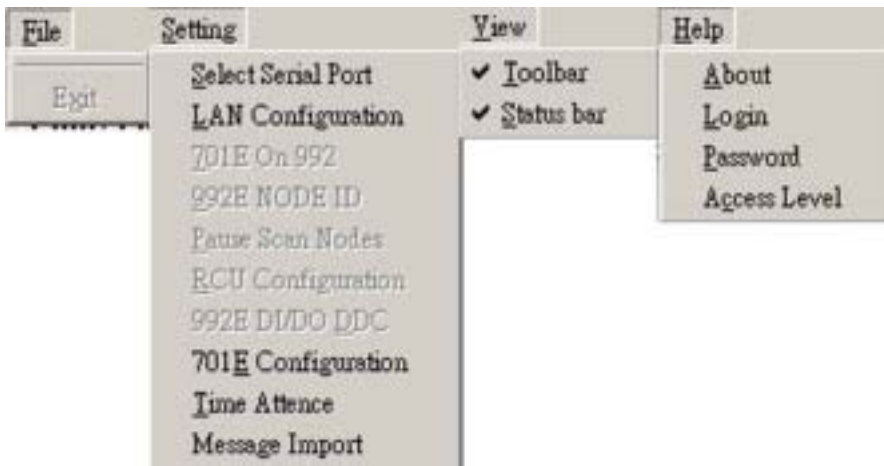

## 1.3 Tool Bar content



## 2. Installation

**Install the 701 Server:** Before installing the Server, make sure both the reader and the controller are well set, the controller is also connected to the computer via a converter (RS485 RS232). Insert the CD-to-CD ROM.

Step 1: Run file [ **701ServerSetup.exe** ] for the following windows:



Step 2: Follow the on-screen instructions to click [ **NEXT** ] until [ **Setup Finished** ] to be Shown on windows.



Step 3: Click [ **Finish** ] to complete the installation.

Step 4: Operator can execute from Start \ Programs \ Soyal Software \ 701 Server.

Step 5: Click the 701 Server Icon  twice to access the Server on the down right corner of the windows.

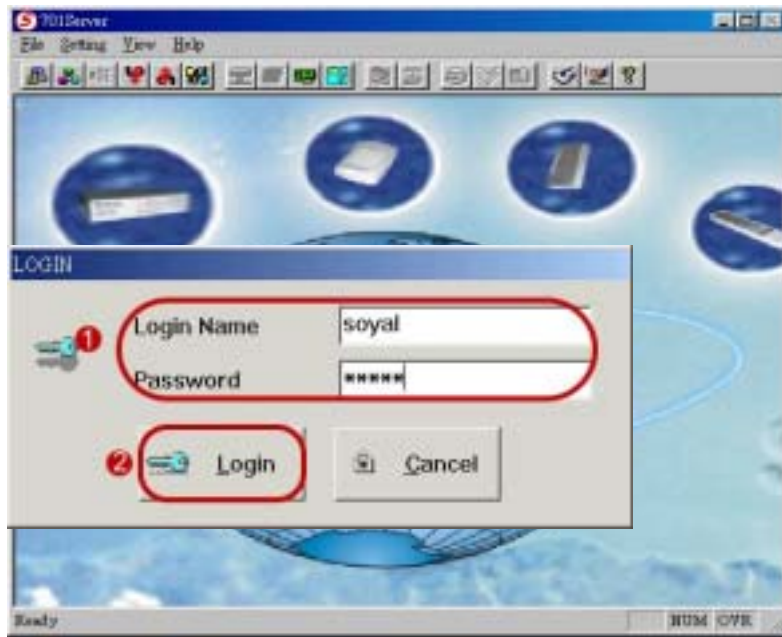

The system will ask to login.

- ① There are two sets of default login. One is [ **supervisor** ] (Operator 1), the other is [ **soyal** ] (Operator 19). Please note the factory settings both on the [Login Name] and [Password] is [ supervisor ] or [ soyal ].
- ② Click **Login** to exit.

### 3. Operator Management

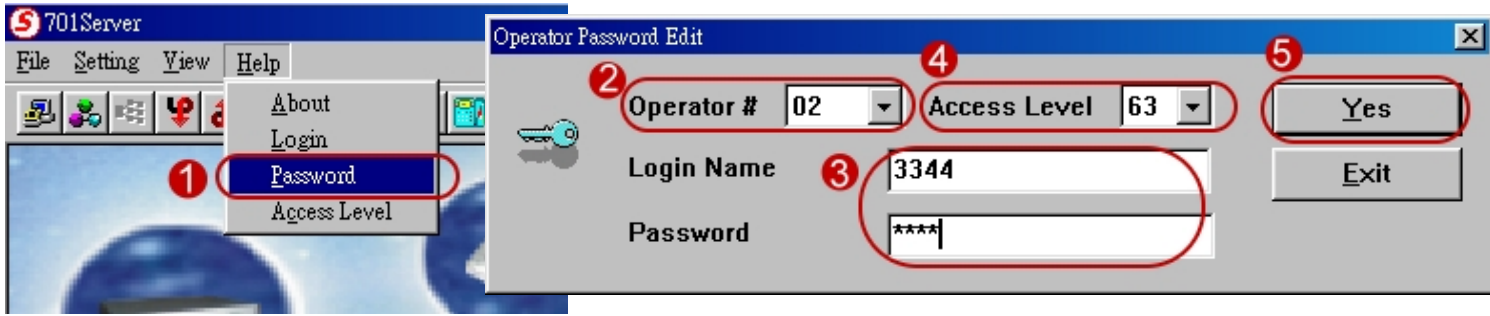

After initialing login with the factory settings (the highest level), users can reset their own favorite [Login Name] and [Password]. The Steps are as follows:

- ① Choose **Password** under the **Help** menu item, then as shown below.
- ② Select operator number.
- ③ Select a favorite [ Login Name ] and [ Password ].
- ④ Select Access Level. (See Also: Access Level under the Help menu item)
- ⑤ Click [Yes] to complete NEW settings.

The [ Login Name ] and [ Password ] consist of any combination of up to 18 characters or 9 Chinese characters. Access Level means a limitation of authority to access the 701 Server, the range is from 0 ~ 63. Access Level 63 is then highest management. Rank access levels from high to low in order of numerals, and 0 is the lowest access levels. The system can support up to 20 Operators that the highest management is also included.

### 4. Access Level

The system provides operators with different access levels ranged from 0 to 63 to manage the software. Click Toolbar Icon  for the following Dialog Box:

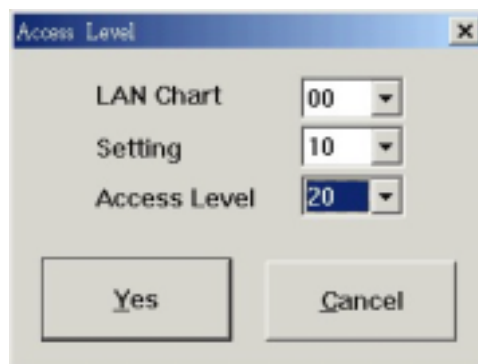

An operator with a proper access level is always recommended (63 is the highest level).

NOTE: Only the operator with access level 63 can login to add/delete/ modify other operators. Operator with access level lower than 63 can login to modify only its own Login Name and Password.

## 5. LAN Base & Communication Port Setting

The system can communicate with networking controller through COM. Port, Modem, TCP / IP or Via Server PC.

- **How to be on-line between PC and controllers?**

Presupposition: controllers and on-line readers connect ok, and Node ID is set ok.

- **How to set networking controllers and on-line reader's Node ID?**

Remark: Please refer to hardware user's manual. Hereby brief explanation:

(1) Networking controller has two series, 7XXE and 829E series.

7XXE's Node ID is set by DIPswitch, and 829E is set by keypad.

(2) On-line reader's Node ID is set by keypad.

### 5.1 How to be on-line between PC and controllers?

After the hardware connect ok, please follow below step.

Step1: Click Toolbar Icon  to set up LAN Base.

Server computer needs to know the type and the Node ID of controllers of the framework (LAN base).

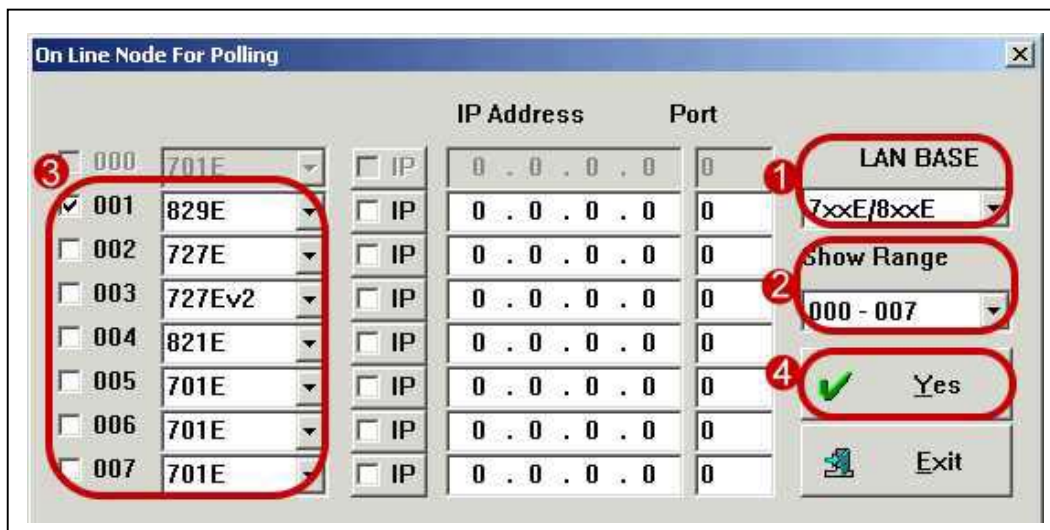

① Select [ LAN BASE ] to 7xxE/8xxE.

② Select the Node ID that will be assigned to the controller. The computer can connect up to 255 sets of controllers. Click the [Show Range] drop down list to select the Node ID range.

③ Click controller Node ID and select controller type from the drop down list.

④ Press [ Yes ].

Note:

(1) When 7XXE series and 8XXE series networking controller are used at the same time, 8XXE series must be set Master Node. (Setting on the 821E/829E Parameter Setting)

(2) When communication type via TCP/IP, we must click IP and enter IP address and TCP/IP port. Two condition:

Condition 1: If head office and subsidiary company is in same LAN, IP Address can be fictitious.

Condition 2: If head office and subsidiary company is not in same LAN, IP Address of Subsidiary

company must be virtual and fixed so that head office monitors its remote subsidiaries with an expanding TCP/IP. Note: IP Address is a site address that applied from the local telephone office.

(3) 727H CPU Version 4.2 – mode 9 directly connect to PC through AR-801CM converter for only Time and Attendance function.

- Can connect to PC through AR-801CM for only Time and Attendance function. (Version 4.2 UP)

Under Mode 9, keep 480 transactions

1000 user cards capacity.

Not support Anti-pass-back, lift control, Time zone and Door group.

Please note transaction record just show normal access Message, without the message from invalid card and Push button.

It can be used together with AR-716E series, AR-829E and AR-821EF networking controller through parallel installation.

Step2: After completed setting LAN Base, click Toolbar Icon  selecting communication port:



## 5.2 Communication port setting via com port or TCP/IP

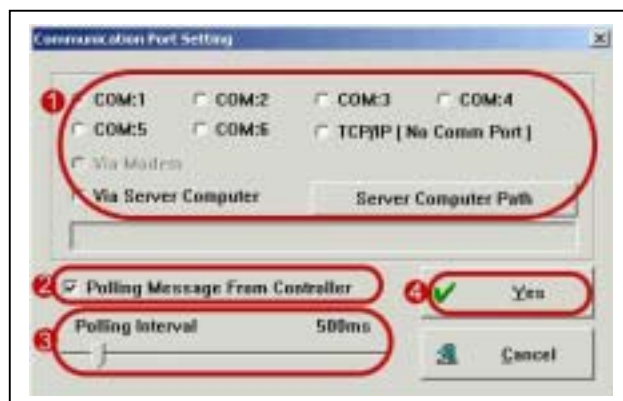

- ① Check if the cable is well connected, and select Communication Port.  
There are two communication ports COM: 1 and COM: 2 in the computer. For Com: 3, Com:4, Com:5, Com:6 and TCP / IP, it will be available only after added with expanding accessories.
- ② Click [ Polling Message From Controller ].
- ③ Select suitable [ Polling Interval ] to poll the messages from controller (recommended to set to 200ms).
- ④ Press [ Yes ] and to save all the settings, the  on the right down corner of the windows will flash that indicates in normal communication. The color of Server Icon indicates the status of communication.  
(1) Red means TRANSMITTING.  
(2) GREEN means RECEIVING.  
(3) WHITE means IDLING.  
(4) BROWN means COMMUNICATION ERROR.

Note:

1. If system configuration has via COM port and Ethernet at the same time, communication port must select COM port.

### 5.3 Communication port setting via Modem

Modem name will be shown on the column space once its driver is installed; otherwise, the column space will be blocked with gray color. If the Modem is the choice, the Toolbar  【Dial-up】 shall turned into color which means a remote connection can be set up. Click and see the following Dialog Box.

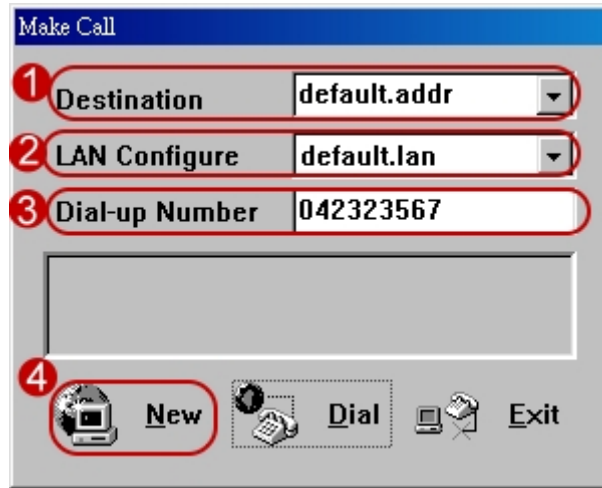

- ① Destination: A Destination File Name for each remote connection.
- ② LAN Configuration: Select an existing LAN Configuration File.
- ③ Dial-up Number: A telephone number of Remote Modem. If there is a modification, the LAN Configuration File Name and Dial-up Number will be updated and linked the Destination File Name only after Dial is clicked.
- ④ New: Once click [ New ], the system will automatically create a new Destination File Name.

Parameters of Modem connected to computer	Parameters of Remote Modem connected to controller
AT&F	AT&F
AT+MS=V32B, 1, 9600, 9600	AT+MS=V32B, 1, 9600, 9600
ATS0=1S2=128S30=1S37=9	ATS0=1S2=128S30=1S37=9
AT\J0-C0&S0	AT\J0-C0&S0
ATN0TQ0&W0	ATN0TQ1&W0
Extra Setting for Computer Modem : follow the sequences	
START    SETTING    CONTROL PANEL    MODEM    OPEN	
PROPERTIES    CONNECTION    ADVANCED    EXTRA SETTINGS	
In extra setting column types ATS2=128, and Click OK	

## 5.4 Communication port setting via Server Computer

The Server Computer shall select the [ Via Server Computer ] communicate with controller. Click Server Path to choose the path to Server Computer. Assign [ Server Path ] to Server Computer via Network Neighborhood.

Note:

1. We name the computer that connect to AR-716EV2 Server Computer, and name other computer Client Computer via Network Neighborhood.
2. Server Computer and Client Computer install both 701 Client and 701 Server software.
3.
  - a. Communication port of Server Computer selects COM port or TCP/IP and click [ Polling Message From Controller ].
  - b. Communication port of Client Computer selects “via server Computer” and direct to server path and don’t click [ Polling Message From Controller ].

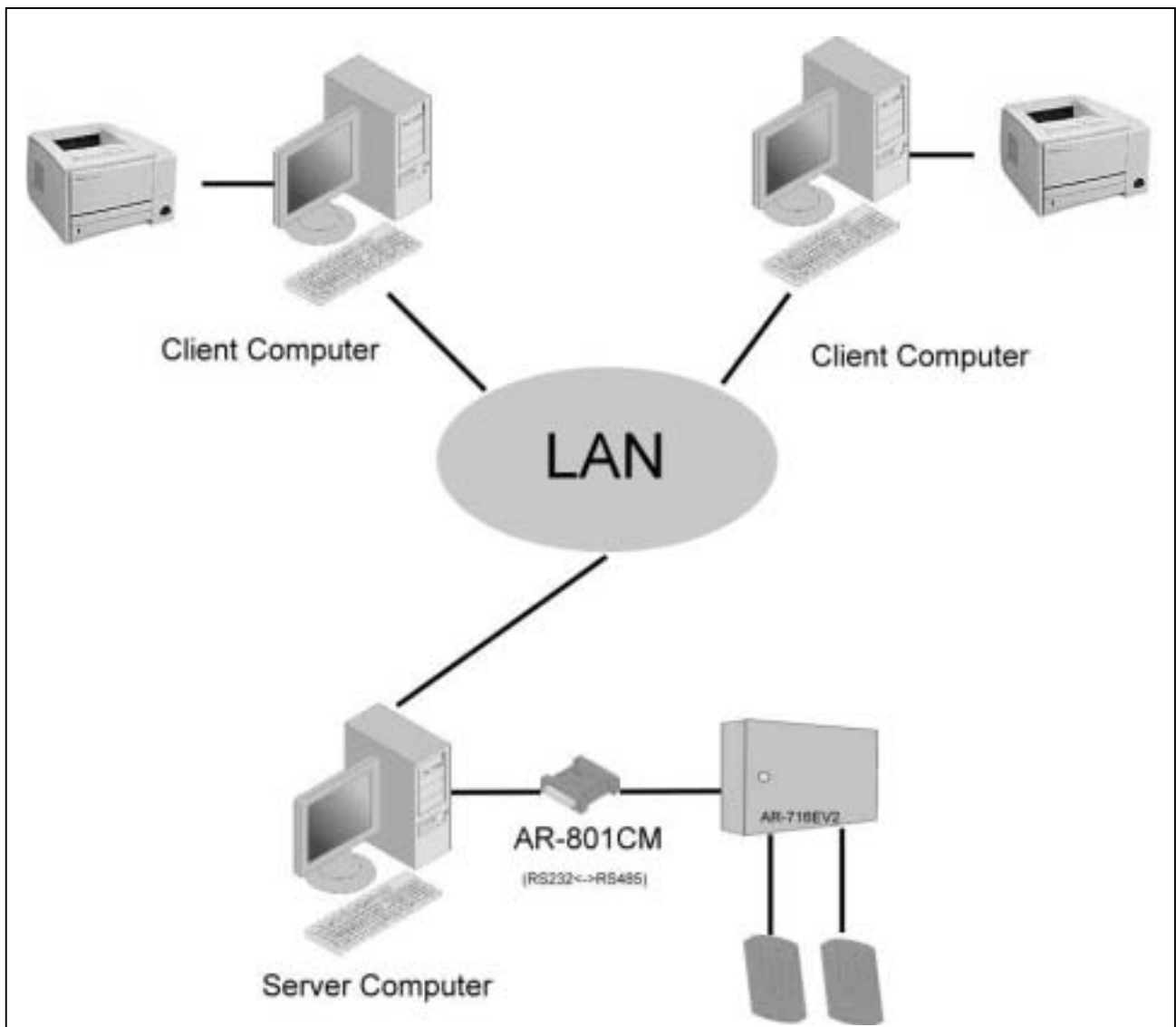

Step 1: Please share Server Computer's path C:\program files\ 701 Server and C:\program files\ 701 Client to Client Computer. (Sharing setting depends on operating system; therefore, we don't explain how to sharing hereby)

Step 2: Client PC's communication port setting

- 1 Click [ Via Server Computer ].
- 2 Direct to server path.
- 3 Don't click [ Polling Message From Controller ].
- 4 Click [ Yes ].



Step 3: Be sure that Server PC and Client PC support "NetBEUI" protocol.

Step 4: Client Computer's project files management setting

- 1 Direct to Server Computer's project files management path
- 2 Click [ Save ].

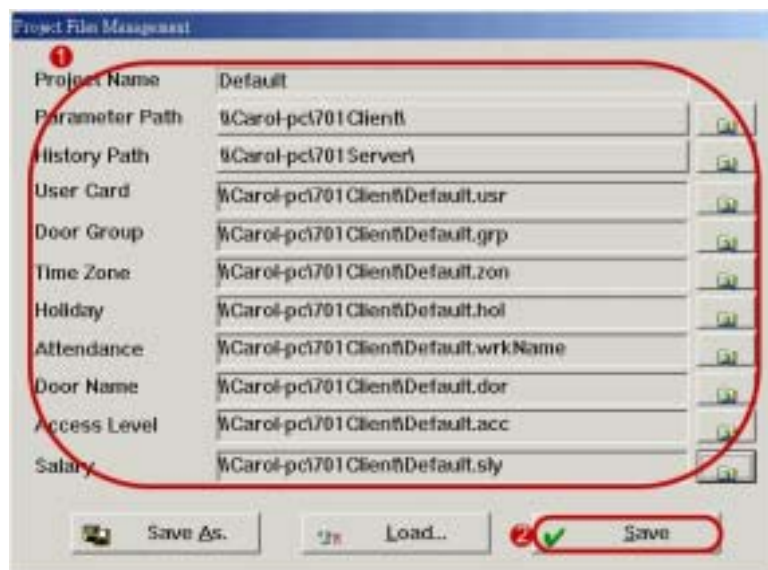

Step 5: Close 701 Client windows and execute 701 Client again.

## 6. Lan Chart

Check the ON/OFF line status of the system devices; click Toolbar  for the following tree structure:

As indicated, the system has one set of AR-829E controller (Node ID 001) and two sets of AR-716EV2 controllers (Node ID 002 and 003).

- (1) White [ ? ] means devices ON or OFF not stable.
- (2) Blue [ Y ] means devices ON line.
- (3) Red [ X ] means devices OFF line.

Click Exit to exit this sub-menu.

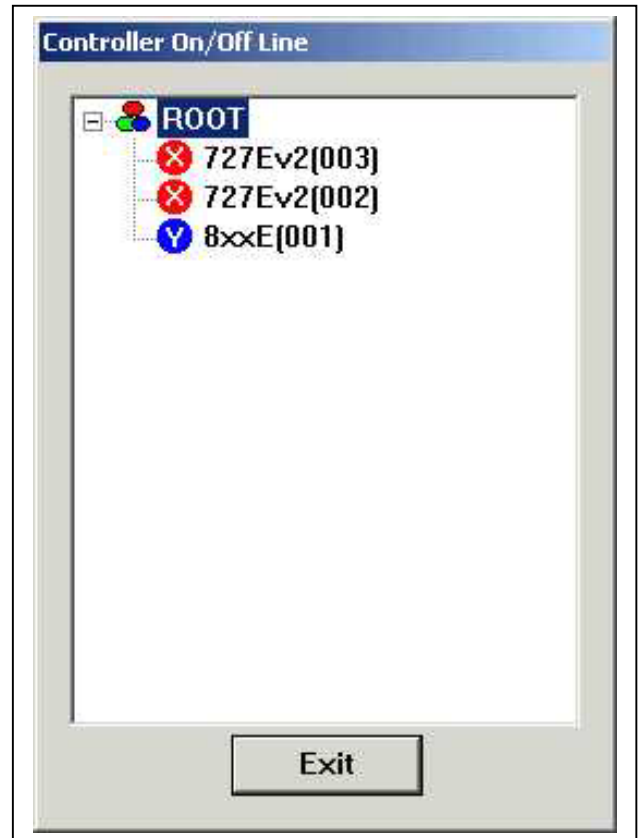

## 7. 701E / 716E Parameter

### 7.1 Program on-line reader location

Program on-line reader location, and assign on-line reader Node ID, door number & parameter setting.

Before on-line reader installation, fill up the "AR-716EV2/716Ei & 721H/727H System Setting Table" for the record. **NOTE: See AR-721H / AR-727H user's guide for more information.**

Step:1

Press  and master code follow an

Step:2

Enter

Range 001~254. Default setting: NNN= 001

Step:3

Press

## 7.2 How to enter 701E / 716E parameter setting

How does the Server receive the Data information from the controller and the reader?

Click Tool Bar Icon  (701E / 716E parameter) for the windows:

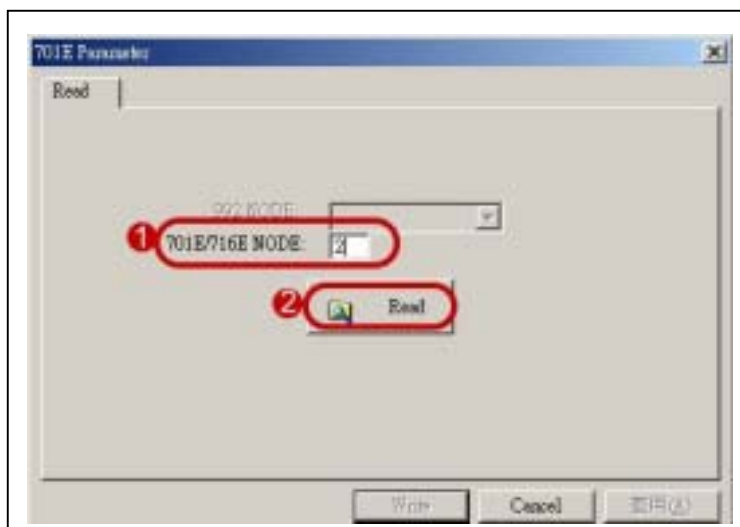

① Select controller number

② Click [ Read ].

Click [ Read ] for only one controller; otherwise, fill up the Controller Number that designated, for example 001 & 002 indicates Controller 1 & Controller 2; then click [ Read ].

## 7.3 On-line Reader

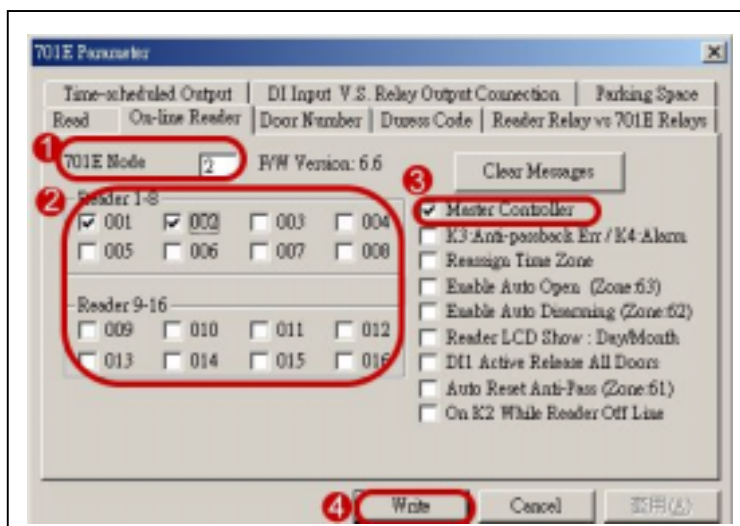

① Present select controller number.

② There are two Channels, Channel 1 & Channel 2, on the controller, each Channel can connect up to 8 readers. From above, for example, there are two readers connected to Channel 1 with Reader 001 & Reader 002, then click [ 001 ] & [ 002 ].

③ Remember to click [ Master Controller ] to prevent the system from On-line communicating badly, especially for more than one controller in the system.

④ Press [ Write ].

The features on the right column are:

(1) **Clear Messages:** Clear all messages in AR-716EV2 or AR-716Ei controller.

- (2) **Master Controller:** Choose this item if it is a Master. There must be only one master controller for all the controllers in the system. It is for using com port diagram. If it is for using Ethernet diagram, you must click this item for all controller in the system.
- (3) **K3 Anti-passback Err/K4 Alarm:** Once this item is chose, violate anti-pass back feature will activate K3 Relay, and for each alarm relay of the reader that connected to this controller is activated will also activate the K4 Relay. The K3/K4 Relays activated time based the time setting (000 ~ 250 seconds) on sub-menu [ DI INPUT V.S. RELAY OUTPUT ].
- (4) **Reassign Time Zone:** Once this item is chose, the system can provide single controller with entry/exit different doors, different Time Zones features; however, the Time Zones in Setting "User Card Edit" will be reduced from 64 to 16 Time Zones.  
Time Zone and Door Number will automatically divided into the following 4 sections.

Time Zone	01-15	17-31	33-47	49 -63
Door Number	01-63	64-127	128-191	192-255

For example,

There are three control door groups as Main Gate & Front Door, Office& R&D Department, Production Line & Warehouse Department.

Time Zone Control	Personnel	Senior Officer	Staff	Operator
<b>Main Gate &amp; Front Door</b>		No	No	No
<b>Office &amp; R&amp;D Department</b>		No	8:00AM - 19:00PM	No
<b>Production Line &amp; Warehouse Department</b>		No	8:00AM - 18:00PM.	8:00AM - 17:00PM

The steps as follows:

Step 1. Assign "Door Number" in the 701 Server\701E / 716E parameter setting \ Door Number.

Door Name	Main Gate	Front Door	Office	R&D Dept.	Production Line	Warehouse Dept.
<b>Door No.</b>	001	002	064	065	128	129

Step 2: Define "Time Zone" in the 701 Client\ Time Zone.

Time Zone	01	17	33	02	18	34
<b>Time</b>	00:00AM - 23:59PM	08:00AM - 19:00PM	08:00AM - 18:00PM	00:00AM - 23:59PM	00:00AM - 23:59PM	08:00AM - 17:00PM.

Staff time zone for 01, 17 and 33; and Operator time zone for 02, 18 and 34.

Step 3: Enter "Time Zone in the 701 Client\ User Card Edit.

User	Senior Officer	Staff	Operator
<b>Time zone</b>	NO	01	02

(5) **Enable Auto Open (Zone: 63):** Once this item is chose, the specified reader(s) will be in LATCH-OFF mode based on the time periods specified on the Time Zone 63 and other linked Time Zones if any. Additionally, each Specified Readers has to be set to enable Auto Open feature using Command 20 from 721H's keypad and command 32 from 727H's keypad. Note: Once the Auto Open Timing is beginning, the door relay of this reader will be in LATCH-OFF mode after the first access. The door relay will automatically activate at the end of this time period.

- a. Define Time Zone in 701 Client\ Time Zone: Maintain Time Zone 063 as Auto Open Timing.
- b. Assign Additional Function from reader keypad.

AR-721H

Step 1: Press  and master code follow an

enter programming mode

Step 2: Enter

NNN: default value 016 (NNN = default value + 4)

Step 3: Press   to exit programming mode.

AR-727H

Step 1: Press  +       +

enter the "FUNCTION MENU"

Step 2: Enter command 32 to start Auto open zone function.

Step 3: Return to main menu and enter command 6 to exit FUNCTION MENU.

(6) **Enable Auto Disarming (Zone: 62):** Once this item is chose, the specified reader(s) will be automatically in Disarming or Arming based on the time periods specified on the Time Zone 62 and other linked Time Zones if any. Note: Once the Auto Disarming Timing is beginning, the readers will be in Disarming mode until end of the time period to become Arming mode. Additionally, each Specified Readers has to be set to enable Remote Control Function feature using Command 20 from 721H's keypad and command 32 from 727H's keypad. The steps as the above "Enable Auto Open (Zone: 63)".

(7) **Reader LCD Show (Day/Month):** Once this item is chose, the date format will be switch from MM/DD/Hour/minute/second.

(8) **DI 1 to Active Release All Doors:** Release all the emergency exits if there is a fire event. This function can be used to release the specified readers (doors) while in an emergency until after making an access normally. Additionally, each specified reader(s) has to be set to enable Door Release Button from its reader keypad.

(9) **Auto Reset Anti-pass (Zone 61):** Once this item is chose, the anti-pass-back will automatically reset and restart. This means to disregard present entry/exit door status of card user and resume the anti-pass-back feature. The momentary reset time is specified on the Time Zone 61.

(10) **On K2 While Reader Off Line:** Once this item is chose, and the k2 relay connect to alarm device. When on-line reader which connect to controller is off-line with the controller, K2 will be active alarm.



## 7.4 Door Number

Assign a Door Number (1 – 255) to each reader. In 701 Client software, user can assign a Door Name for each Door Number. Please note the meanings of Reader Node ID and Door Number are different. Door Number means number that assigned to each door, but Reader Node ID means number that assigned to controller and reader. The Door Number can be repeated.

For example, there are two sets of AR-716EV2 controllers together with one set of AR-829E controller in the Framework, and each AR-716EV2 controller connect 2 readers. Assign Reader Node ID “001” & “002” to AR-716EV2 respectively, then Reader Node ID “003” to AR-829E reader. In fact, the factory setting of 829E is 001. Remember the reader Node ID 003 has been assigned and it will not be able to use to assign to other readers any more; otherwise, an abnormal communicating status will be occurred. Setting Reader Number by Command 00.

Press        (NNN means Reader Node ID.)

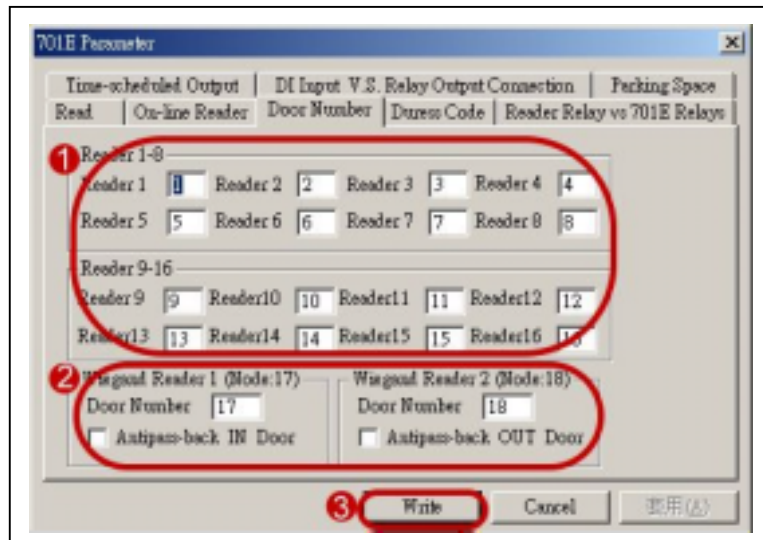

- ① Input reader door number
  1. Reader 1-8 is the door number of the CH1 RS-485 readers.  
(The CH1 can connect to on-line reader Node ID 1-8).
  2. Reader 9-16 is the door number of the CH2 RS-485 readers.  
(The CH2 can connect to on-line reader Node ID 9-16).Note: The above Door number can be both changeable.
- ②
  1. Node ID of WG reader port 1 is fixed to no.17 on the 716EV2/Ei PCB.  
If enable anti-pass-back, Node ID 17 is fixed to be in door.
  2. Node ID of WG reader port 2 is fixed to no.18 on the 716EV2/Ei PCB.  
If enable anti-pass-back, Node ID 18 is fixed to be out door.Note: The above Door number can be both changeable.
- ③ Press [ Write ].

## 7.5 Duress Code & Force On / Off Code

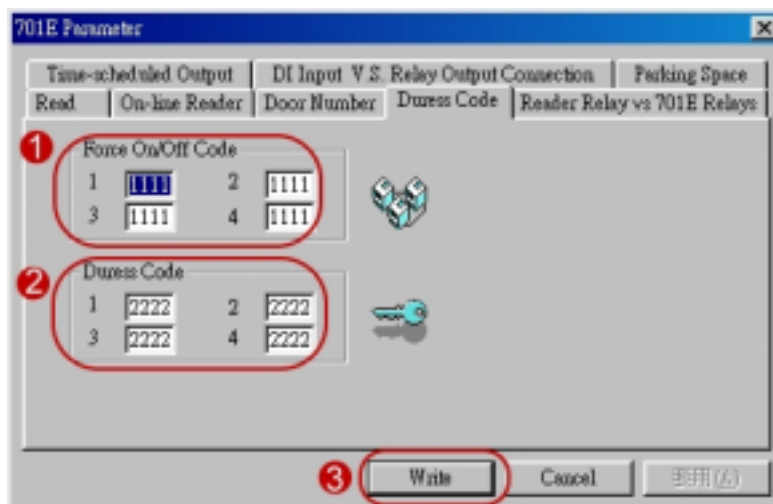

- 1 User can assign up to 4 Force On/Off Codes for all the readers that connected to this controller. These codes can be used to on/off the relays on the controller After card access successfully, input 4 Force On/Off Codes, Relay Number, and F1 to activate (F2 to deactivate) a specified 716EV2/Ei Controller Relay.
- 2 User can assign up to 4 Duress Codes for all the readers that connected to this controller. Instead of user Card Code, input Duress Codes on reader panel for access, computer will instruct to open door, at the same time a message will be sent for help.
- 3 Press [ Write ].

## 7.6 Reader Relay vs 701E Relays

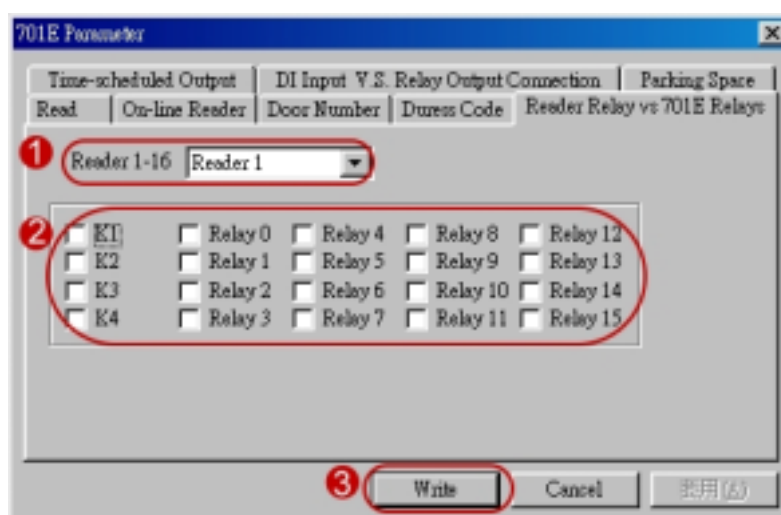

- 1 Select reader number
- 2 User can assign up to 20 relays ( But AR-716EV2/Ei just has four sets of relays for K1, K2, K3 and K4 ) on the controller to synchronize with the Door Relay of each reader. Instead of using the outdoor use Reader Door Relay, user can use Controller Relay to open the door that can increase the safety of the system.
- 3 Press [ Write ].

## 7.7 Time-Scheduled Output

The controller (7xx Series) can support 4 different bells, for example, company factory Regular TIME IN/TIME OUT bells, Lunch TIME IN/TIME OUT bells.

From the Relays K1 ~ K4 on the controller, up to 12 designated Time-scheduled Outputs can be set per day, 7 days a week. 000 means no activated time. The activated time of relays ranges from 001 ~ 250 seconds. As indicated below:

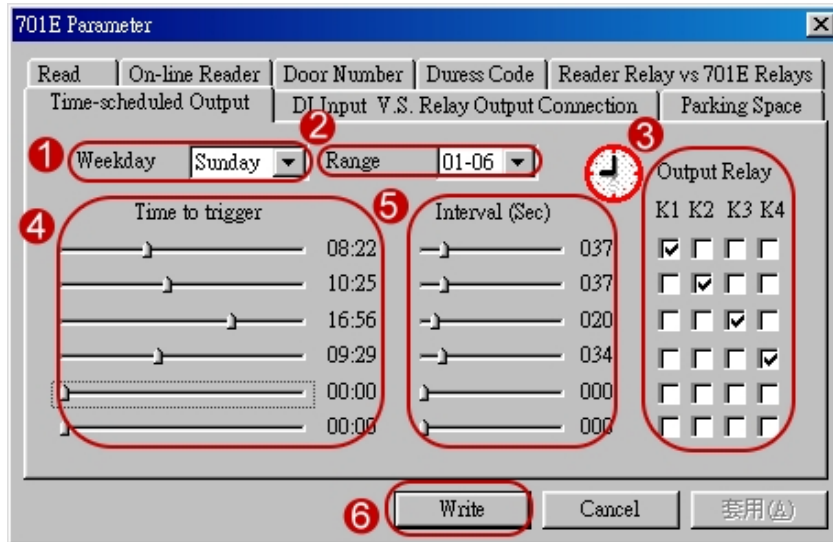

- ① Select "Weekday"
- ② The "Ranges" can assign 12 designated Time-scheduled Outputs. Time zone 1 to Time zone 6 are on the first page, select from the drop down list for Time zone over 6.
- ③ From the Relays K1 ~ K4 on the controller, can connect up to 4 different bells.
- ④ Allow differently the time of trigger bells.
- ⑤ From the activated time of relays, can adjust time of bells.
- ⑥ Press [ write ]

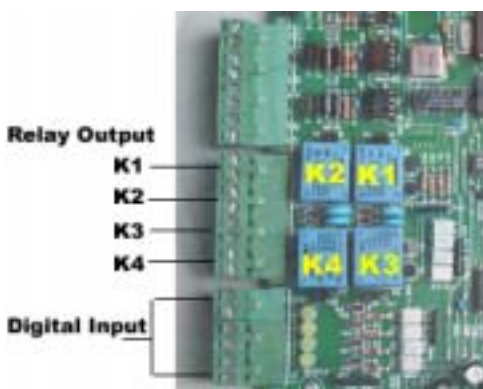

716EV2 Controller,  
Relay Output & DI Input

## 7.8 DI Input V.S. Relay Output Connection

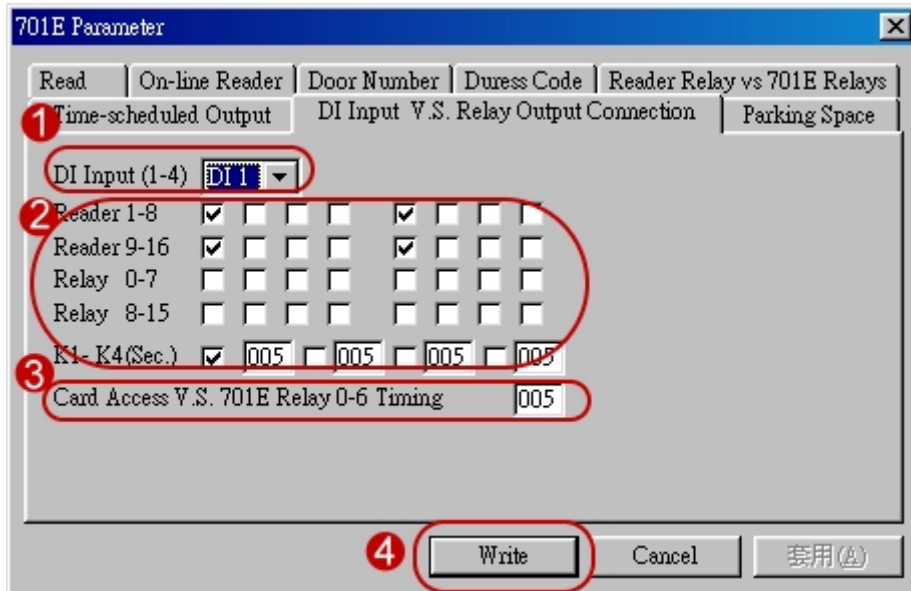

- ① The controller has 4 DI inputs, it can activate the controller relays or readers Door Relays that are selected.
- ② If DI input connected to the reader, once the DI input is activated, the reader Door Relays are activated for a period of time (Door Opening Setting on the reader itself.) If DI input connected to Relays 00 ~ 15 (this function is just suitable for AR-701E) , once the DI input is activated, the relays on the controller that assigned to the DI inputs are also activated synchronously. If DI input connected to Relays K1 ~ K4, once the DI input is activated, the Relays K1 ~ K4 are activated for times that are based on the time setting (001 ~255 seconds) of this menu. As settings, the DI 1 is activated, the controller Relay K1 is activated for 5 seconds. If the time setting is 000, then the relay is in LATCH-ON/LATCH-OFF toggle mode, and the situation will be changed until DI input being activated next time.

DI-0: It can be NO Momentary (Sink) or Voltage (Source, 12VDC) input, and can be selected by ON/OFF switch inside of the controller.

1. The DI.2 is exit button input of WG reader port 1 and the K1 is open door relay.
  - (1) Choose “DI 2” under the menu item.
  - (2) Click “K1”.
2. The DI.3 is exit button input of WG reader port 2 and the K2 is open door relay.
  - (1) Choose “DI 3” under the menu item.
  - (2) Click “K2”.

Note: Active second can be set only when the window is DI 1.

- ③ Once the cardholder accesses the door successfully, the controller relays are activated for a certain period of time based on the time setting as above, for example, 5 seconds.  
The setting time is 001 – 255 seconds. 000 for LATCH-ON (this function is just suitable for AR-701E).
- ④ Press [ Write ].

## 7.9 Parking Space

The controller provides parking spaces with All Full or All Empty monitoring functions, assign any one of the 20 controller relays for its All Full or All Empty indication respectively.

701E Parameter

Read | On-line Reader | Door Number | Duress Code | Reader Relay vs 701E Relays

Time-scheduled Output | PI Input V.S. Relay Output Connection | Parking Space

Total Space: 500

Total Inside: 0

All Full Relay: Relay 1

All Empty Relay: Relay 2

Write | Cancel | 套用(A)

① Before initiating use, enter total car spaces, total car inside parking lots.

② And assign All Full & All Empty activated output relays.

However, the function is only applied to the initiating use anti-passback user cards to entry/exit anti-passback control door.

## 8. 821E / 829E Parameter Setting

### 8.1 Program AR-829E/821EF single-door networking controller location

Assign AR-829E/821EF Node ID, door number & parameter setting by software and keypad.

Before AR-829E/821EF installation, fill up the “AR-829E / 821EF System Setting Table” for the record. **NOTE: See AR-829E / AR-821EF user’s guide for more information.**

Set Node ID by keypad shown bellow:

Step 1: Press  +       +  enter the “FUNCTION MENU”

Step 2: Enter command 31 to edit Node ID.

Step 3: Return to main menu and enter command 6 to exit FUNCTION MENU.

### 8.2 How to enter AR-829E/821EF parameter setting

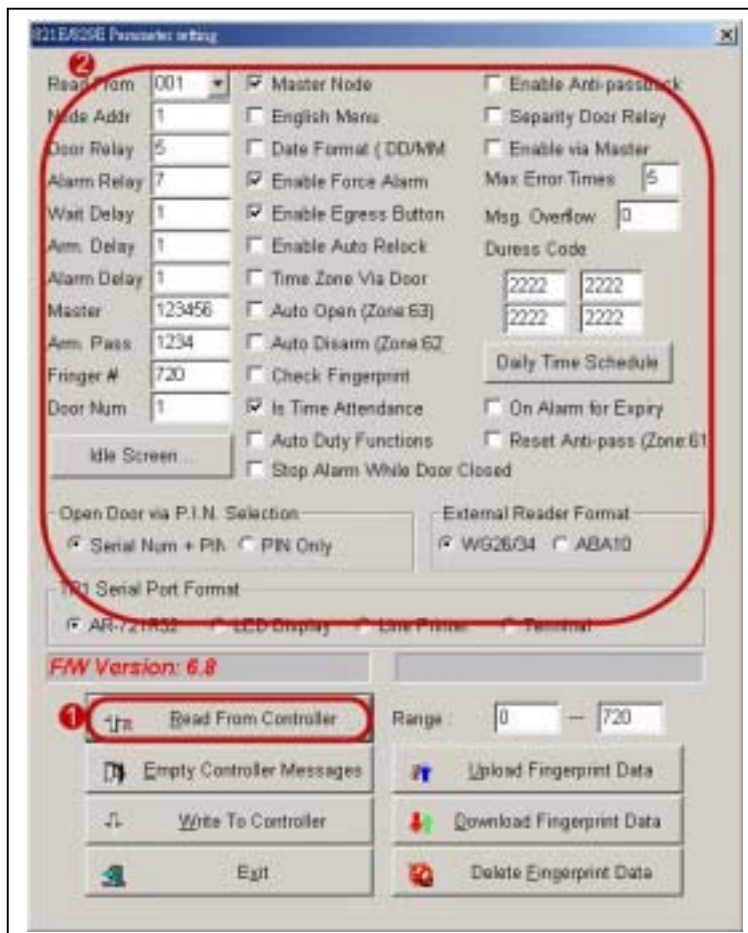

① Click [ Read From Controller ]

② Then show factory default.

### 8.3 How to assign Door Number?

Step 1: Enter Door Number in the “Door Num.” position. Default value is 1, so we suggest that please assign door number same with Node ID to avoid message is error from controller read in the future.

Step 2: Click [ Write To Controller ].

### 8.4 How to change Node ID by software?

Step 1: Enter new Node ID in the “Node Adr.” position.

Step 2: Click [ Write To Controller ].

### 8.5 How to change master code by software?

Step 1: Enter new 6-digit master code in the “Master” position.

Step 2: Click [ Write To Controller ].

### 8.6 Time schedule for Door Relay, Wait Delay (Door Close Tm), Alarm Delay, Alarm Relay

#### Timing 1 Sequence-

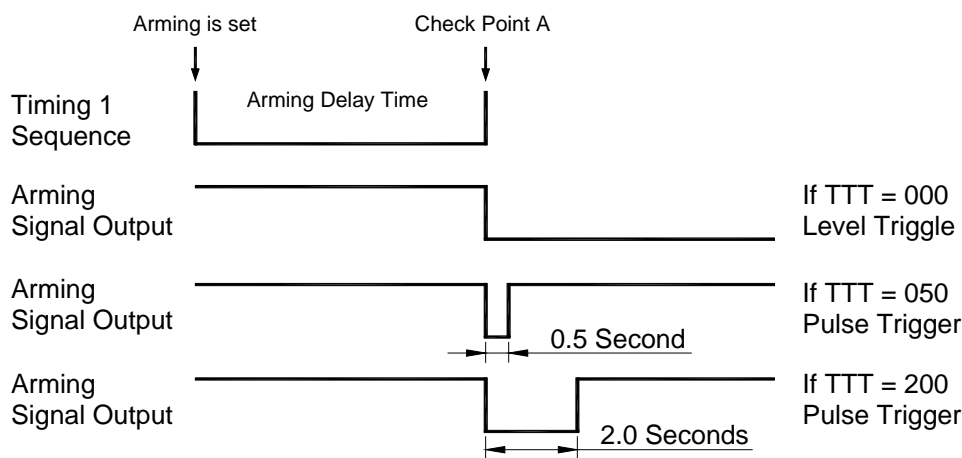

After arming is set, the system enters **Timing 1 Sequence**. Right on **Check Point A**, the system is in arming situation and enters **Arming Mode**.

If door is close, the system engages the **Timing 2 Sequences**.

If abnormal condition arisen, will cause Alarm, e.g. Door open too long (over allowed time), Force open, violating anti-pass-back regulation

#### Timing 2 Sequences-

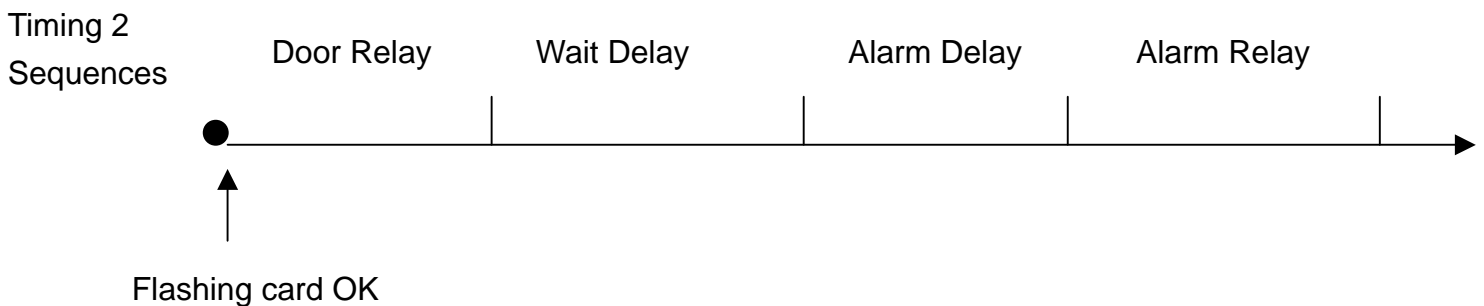

**Arm. Pass:** User presses      after access the door, then the unit will toggle the arming/disarming mode. Default value: 1234 (4-digits).



## 8.7 How to change standby mode's title on the LCD display?

Step 1: Click [ Idle Screen ].

Step 2: There are two rows can be written on the LCD display. Then click [ OK ] to exit.



Step 3: Click [ Write To Controller ].

## 8.8 Duress Code

User can assign up to 4 sets of Duress Codes for AR-829E / AR-821EF. Instead of user Card Code, input Duress Codes on the keypad for access, computer will instruct to open door, at the same time a message will be sent for help.

## 8.9 Daily Time Schedule

The AR-829E/AR-821EF controller can support one set of bell, for example, company factory Regular On Duty, Off Duty, Break Out, and Break In bell.

From Alarm Relay on the controller, up to 12 designated Time-scheduled Outputs can be set per day, 7 days a week. 000 means no activated time. The activated time of relays ranges from 001 ~ 250 seconds. As indicated below:

- ① Select "Weekday".
- ② Allow differently the time of trigger bells.  
From the activated time of relays, can adjust time of bells.
- ③ Click [ Yes ].

Note that if time attendance depends on function key of the Controller, this function supports auto-run duty as the right table.

For example, enter 8:00 in the On Duty position and enter 12:00 In the Break Out position, when it is 8:00 O'clock on Monday,

It will show Duty:0 on the LCD display of the device, until 12:00 O'clock, LCD display will change to BRK:0 status. It is convenient that user don't select duty via function key before flashing card in the status when time attendance depends on function key.

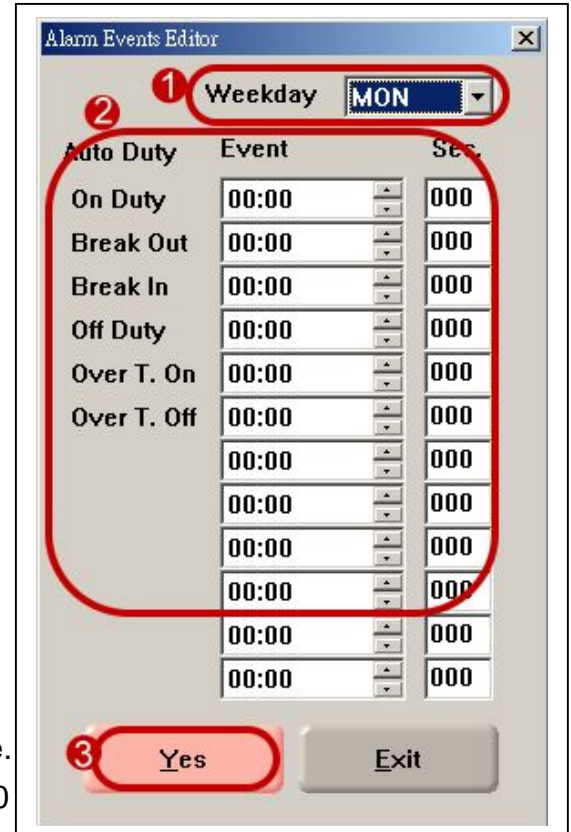



## 8.10 Other function

- (1) **Empty Controller Messages:** Clear all messages on AR-829E / AR-821EF controller.
- (2) **Master Node:** Choose this item if it is a Master. There must be only one master controller for all the controllers in the system. It is for using com port diagram. If it is for using Ethernet diagram, you must click this item for all controller in the system.
- (3) **English Menu:** Choose this item, LCD display will be shown in English.
- (4) **Date Format (DD/MM):** Once this item is chose, the date format will be switch from MM/DD/Hour/minute/second.
- (5) **Enable Force Alarm:** Once this item is chose, when door is open via forced open action in the disarming mode, alarm relay will be triggered active.
- (6) **Enable Egress Button:** Once this item is chose, user can access the door via press push button.
- (7) **Enable Auto Relock:** Once this item is chose, door sensor feels the door status is close, it will auto re-lock.
- (8) **Auto Open (Zone: 63):** Once this item is chose, the AR-829E / AR-821EF will be in LATCH-OFF mode based on the time periods specified on the Time Zone 63 and other linked Time Zones if any. Note: Once the Auto Open Timing is beginning, the door relay of this reader will be in LATCH-OFF mode after the first access. The door relay will automatically activate at the end of this time period.
- (9) **Auto Disarm (Zone: 62):** Once this item is chose, the AR-829E / AR-821EF will be automatically in Disarming or Arming based on the time periods specified on the Time Zone 62 and other linked Time Zones if any. Note: Once the Auto Disarming Timing is beginning, the readers will be in Disarming mode until end of the time period to become Arming mode.
- (10) **Reset Anti-pass (Zone 61):** Once this item is chose, the anti-pass-back will automatically reset and restart. This means to disregard present entry/exit door status of card user and resume the anti-pass-back feature. The momentary reset time is specified on the Time Zone 61.
- (11) **Check Fingerprint:** Once this item is chose, user can access the door via flash card + fingerprint or 4-digit user address + F4 function key + fingerprint.
- (12) **Is Time Attendance:** Once this item is chose, event transactions on the controller will put into time attendance report. Ex. Daily Time and Attendance Report and Multi-day Time and Attendance Report.
- (13) **Auto Duty Functions:** Once this item is chose, LCD display of the controller will show duty on the above right corner.
- (14) **Stop Alarm While Door Closed:** Once this item is chose. User can be disarming by door closed, when alarm relay is triggered.
- (15) **Enable Anti-pass-back:** Once this item is chose. The AR-829E / AR-821EF and one set of wiegand reader (AR-721U, AR-721K or AR-661U) will have anti-pass-back function for each other. Note that card also needs to enable anti-pass-back function by 701 client \ user card edit.
- (16) **Separate Door Relay:** Once this item is chose, WG reader that connects to AR-829E / AR-821EF can control separate door. Note that this function cannot use with arming function at the same time.

Station field will add t 'Exit' to distinguish transaction record between AR-829E / AR-821EF and its slave reader in Daily Transaction Record. Therefore, please notice the following message.

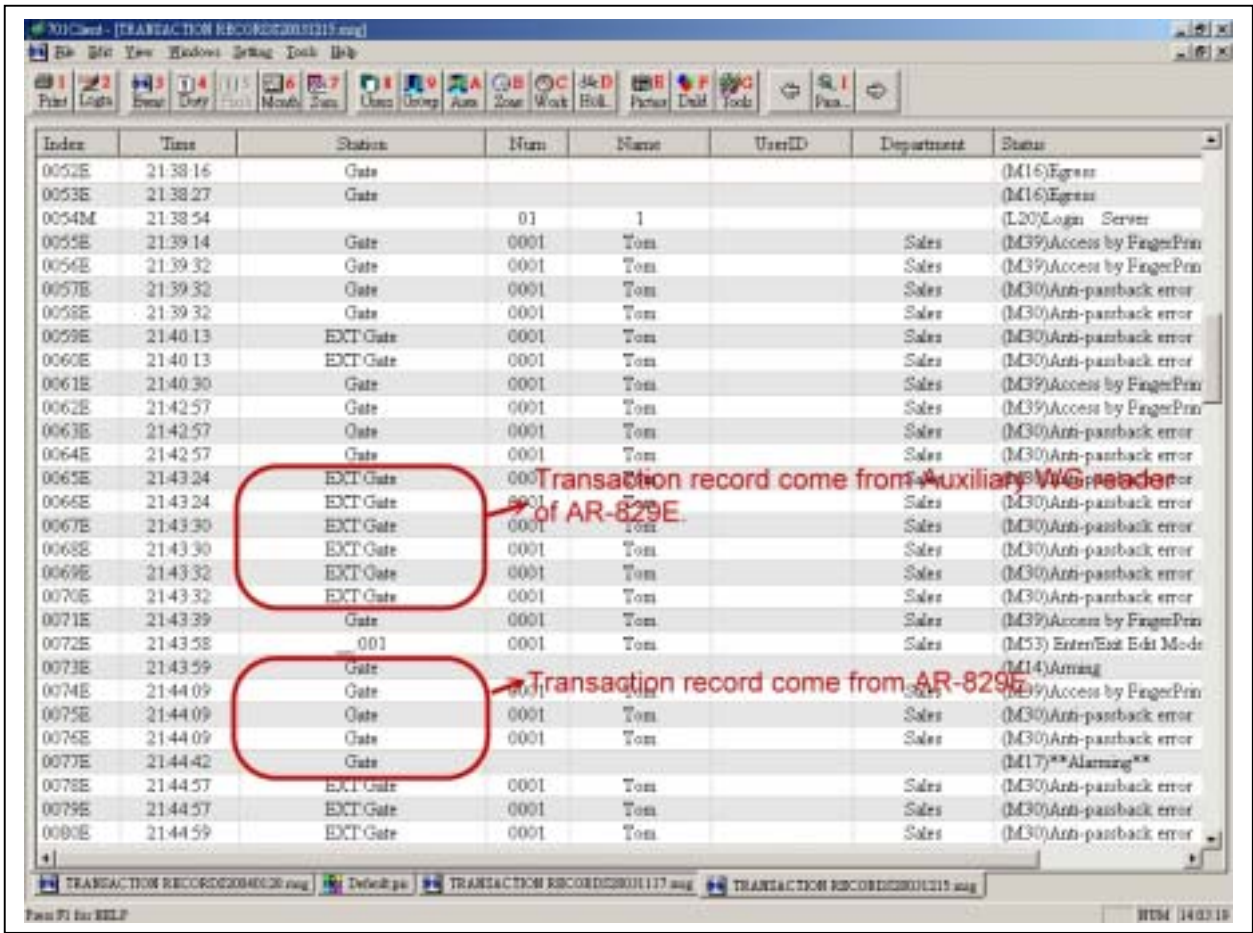

(17) **Enable via Master:** There are 5 user cards, started from user address 0000 to 0004, to enable or disable “ Door Access ” function. The feature is used for those companies that need someone in particular to enable or disable reader with “ Door Access ” function everyday. The person must be on duty in the earliest and off duty at the latest. The employees can access door to work after this function has been generated; when disabled, the employees cannot access door anymore.

Controller operating method: After flashing card, pressing **[F1]** function key within 2 seconds, will enable or disable the function.

[ Enable ] Reader – It only can enable under the access mode by flashing card.

[ Disable ] Reader – It can enable both under the access mode by flashing card or pressing 5-digit user address + 4-digit user Code.

Note that be sure to press **[F1]** function key after flashing card, otherwise, there will only be as general transaction records.

Such as below illustration:

0006M	08:53:26		02	1	(L20)Login
0007M	08:53:32		02	1	(L21)Logout
0015E	08:55:43	001.Royal Hoyel	0000	Andrew	(M11)Normal Access
0016E	08:55:48	001.Royal Hoyel	0000	Andrew	(M11)Normal Access
0017E	08:55:49	001	0000	Andrew	(M44)Enable Reader
0008M	08:56:04		02	1	(L20)Login
0009M	08:56:07		02	1	(L21)Logout

Note that there will only be enable / disable reader records on the Daily Transaction Record.

- (18) **Max Error Times:** Keypad will be locked for 30 seconds, while continuous “N” times error operation for PIN Code & Master Code. Default: 3 times, N: 0-9, if you don’t want this function, you can enter “0” to cancel this function.
- (19) **Msg. Overflow:** The storage of messages of controller AR-829E for 17,000 records and AR-821EF are 1,1000 records. While the PC is on OFF-line status, the numbers of present messages will be shown on controller LED display. For example, the 829E is off-line with PC, it can stores 17,000- transactions within its memory chip and upload those transactions (Datas) automatically to the PC when ever the PC link is established, this way the reader creates new space for recording new transactions. If, its memory is full, the latest ones will replace old transaction. It means it is not necessary that the PC must be "ON" always to keep records of every transaction. The [ Msg. Overflow ] feature is used to remind user open the PC to poll messages by the device sounds beep after user flash card every time when message storage is high than the presenting numbers (if it is set 10,000). If you don’t want this function, you can enter “0” to cancel this function.
- (20) **On Alarm for Expiry:** Once this item is chose. When someone flashes overdue card on the device, alarm relay will be triggered.
- (21) **Open Door via P.I.N. Selection:** It is good for the access mode of Card or PIN. Usually, if you select card or PIN access mode, user can access the door by just either flash card or entering 5-digit user address + 4-digit PIN +  # for Serial Num + PIN Only selection. If you click this selection for PIN Only, user can access the door by just either flash card or directly entering 4-digit PIN.
- (22) **External Reader Format:** AR-829E / AR-821EF can be external one set of auxiliary reader for WG26/34 format (Default) or ABA10 format.
- (23) **TP1 Serial Port Format:** Universal serial port supported for LED display, printer, lift controller, etc.
- (24) **Upload Fingerprint Data:** We can deliver every fingerprint from one controller to the pc depending on this function. Please refer to AR-821EF user’s guide for detailed explanation.
- (25) **Download Fingerprint Data:** We can download every fingerprint to another controller. Upload / download fingerprint Data Function are used to save time when we edit many controllers. Please refer to AR-821EF user’s guide for detailed explanation.
- (26) **Empty Fingerprint Data:** Delete all fingerprint database on AR-821EF. Please refer to AR-821EF user’s guide for detailed explanation.

## 9. Time Attendance

Choose Time Attendance under the **Setting** menu item, then as shown right:



- 1 There are two types of Time & Attendance that selected in the Time Attendance. Please select either one for your Time & Attendance type.
  - (1) **First and Last Record:** The system will treat the first record (first record after 4:00AM) and last record (last record before 4:00AM next day) of the day as employee TIME-IN and TIME-OUT respectively.
  - (2) **Depend on Function:** There is Function Keys on the reader and can set Regular Hours TIME-IN/TIME-OUT, Temporary TIME-IN/TIME-OUT by just press the right Function Keys for Time & Attendance Records.

The software doesn't support 3 shifts, however, it provides with overnight function.
- 2 Click Maximum User On System depends on your requirement. Don't change any more once choose it.
- 3 Mark [ Download clock to reader while program start ! ].
- 4 Press [ ok ]

### Other function:

- (1) **Duty Start Time:** The on-duty time will be treated as same day if the TIME-OUT is over 24:00PM and before 03:59AM next day.
- (2) **Backup Message File To Second Path:** Usually, we put daily message into the default path C:\Program Files\701 Server if user doesn't change the path when installs software. This function is used to daily message also be backup to another path in the same time. How to do? Just click it and direct the path which you want to backup.
- (3) **Call the Process while Startup:** If you want to execute 701 Server, wake up another program (ex. 701 Client) in the same time. Just click it and direct the path that you want to wake up program.

## 10. Message Import

It is good for some company locate its branch office that installs proximity reader in the suburbs that there is no Ethernet area. We can take notebook to receive daily message to here in regular time. Because parent company also installs proximity reader, it will also generate daily message every day in the path C:\Program Files\701 Server. Daily message file of branch office (hereinafter referred to as B) cover daily message file of parent office (hereinafter referred to as A) in order to avoid import message. We need to open one folder for “B” in advance in the “A” path C:\Program Files\701 Server. For example, we put “B” 20021001.msg, 20021002.msg and 20021003.msg to the folder named branch office. Then we import these messages one by one via Message Import under the **Setting** menu item. The steps as follows:

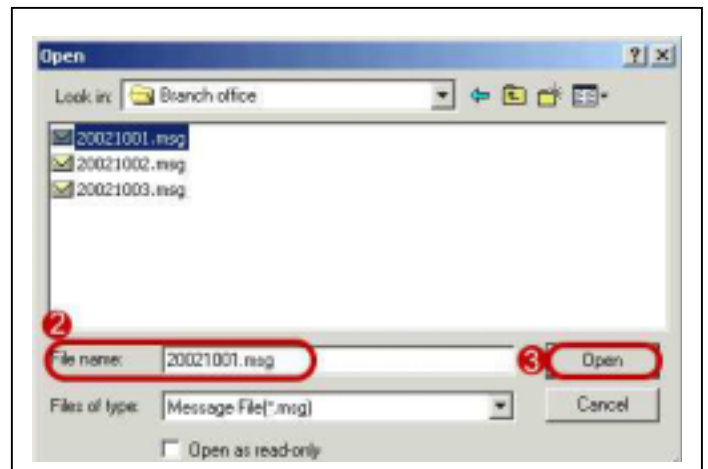
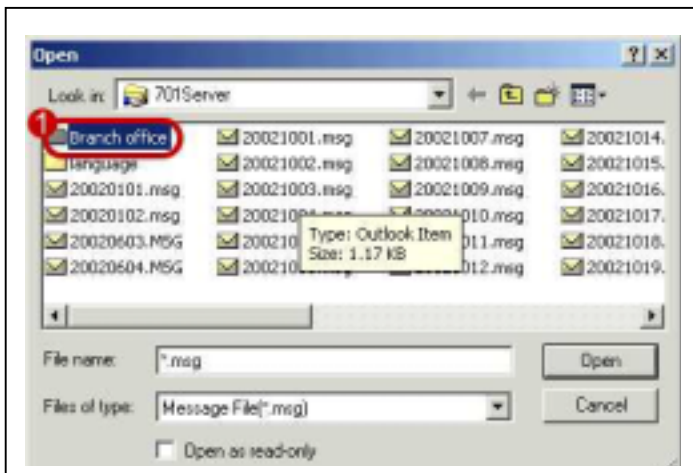

- 1 Click “Branch office folder”.
- 2 Click the message that would like to import one by one.
- 3 Click “Open”, then message is import immediately to the file 20021001.msg of parent company to combine one file.

The difference between before import and after import shown as follows:

Index	Time	Station	Nun	Name	UserID	Department	Status
0000M	19:13:49						(L21)Logout Client
0001M	19:14:01						(L20>Login Client
0002M	08:14:34						(L21)Logout Client
0003M	08:14:40		99	soyal			(L20>Login Clerk
0004E	08:14:48	Soyal Hotel	0004	Jack	1005	Dep_05	(M11)Normal Access
0005E	08:14:49	Soyal Hotel	0005	Caven	1006	Dep_01	(M11)Normal Access
0006E	08:14:51	Soyal Hotel	0003	San	1004	Dep_05	(M11)Normal Access
0007E	08:14:52	Soyal Hotel	0002	David	1003	Dep_03	(M11)Normal Access
0008E	08:14:53	Soyal Hotel	0001	Tom	1002	Dep_03	(M11)Normal Access
0009E	18:46:01	Soyal Hotel	0001	Tom	1002	Dep_03	(M11)Normal Access
0010E	18:46:03	Soyal Hotel	0002	David	1003	Dep_03	(M11)Normal Access
0011E	18:46:04	Soyal Hotel	0003	San	1004	Dep_05	(M11)Normal Access
0012E	18:46:06	Soyal Hotel	0005	Caven	1006	Dep_01	(M11)Normal Access
0013E	18:46:08	Soyal Hotel	0004	Jack	1005	Dep_05	(M11)Normal Access



701Client - [TRANSACTION RECORDS20021001.msg]

File Edit View Windows Setting Tools Help

Print Login Event Duty Flash Month Sum Users Group Area Zone Work Holi... Pictur Dnid Tools Para...

Index	Time	Station	Num	Name	UserID	Department	Status	Detail
0000M	19:13:49		99	soyal			(L21)Logout Client	
0001M	19:14:01		02	1			(L20)Login Client	
0002M	08:14:34		02	1			(L21)Logout Client	
0003M	08:14:40		99	soyal			(L20)Login Client	
0004E	08:14:48	Soyal Hotel	0004	Jack	1005	Dep_05	(M11)Normal Access	
0005E	08:14:49	Soyal Hotel	0005	Caven	1006	Dep_01	(M11)Normal Access	
0006E	08:14:51	Soyal Hotel	0003	San	1004	Dep_05	(M11)Normal Access	
0007E	08:14:52	Soyal Hotel	0002	David	1003	Dep_03	(M11)Normal Access	
0008E	08:14:53	Soyal Hotel	0001	Tom	1002	Dep_03	(M11)Normal Access	
0009E	18:46:00					Dep_03	(M11)Normal Access	
0010E	18:46:00					Dep_03	(M11)Normal Access	
0011E	18:46:04	Soyal Hotel	0003	San	1004	Dep_05	(M11)Normal Access	
0012E	18:46:06	Soyal Hotel	0005	Caven	1006	Dep_01	(M11)Normal Access	
0013E	18:46:08	Soyal Hotel	0004	Jack	1005	Dep_05	(M11)Normal Access	
0014M	18:46:27		02	1			(L20)Login Server	
0015E	08:40:45	Royal Hoyal	0006	carol	1007	Dep_05	(M11)Normal Access	
0016E	08:40:51	Royal Hoyal	0007			Dep_05	(M11)Normal Access	
0017E	08:40:52	Royal Hoyal	0001	Tom	1002	Dep_03	(M11)Normal Access	
0018E	08:40:52	Royal Hoyal	0002	David	1003	Dep_03	(M11)Normal Access	
0019E	08:40:53	Royal Hoyal	0005	Caven	1006	Dep_01	(M11)Normal Access	
0020E	08:40:55	Royal Hoyal	0004	Jack	1005	Dep_05	(M11)Normal Access	
0021E	08:40:56	Royal Hoyal	0003	San	1004	Dep_05	(M11)Normal Access	
0022E	13:49:18	Royal Hoyal	0004	Jack	1005	Dep_05	(M11)Normal Access	
0023E	13:49:22	Royal Hoyal	0004	Jack	1005	Dep_05	(M11)Normal Access	
0024E	13:49:31	Royal Hoyal	0004	Jack	1005	Dep_05	(M11)Normal Access	
0025E	13:54:37	Royal Hoyal	0003	San	1004	Dep_05	(M11)Normal Access	
0026E	13:54:44	Royal Hoyal	0003	San	1004	Dep_05	(M11)Normal Access	
0027E	14:00:35	Royal Hoyal	0004	Jack	1005	Dep_05	(M11)Normal Access	
0028E	14:07:16	Royal Hoyal	0004	Jack	1005	Dep_05	(M11)Normal Access	
0029E	14:08:05	Royal Hoyal	0004	Jack	1005	Dep_05	(M11)Normal Access	
0030E	14:09:23	Royal Hoyal	0004	Jack	1005	Dep_05	(M11)Normal Access	
0031E	14:11:30	Royal Hoyal	0004	Jack	1005	Dep_05	(M11)Normal Access	
0032E	14:11:53	Royal Hoyal	0004	Jack	1005	Dep_05	(M11)Normal Access	
0033E	14:12:00	Royal Hoyal	0004	Jack	1005	Dep_05	(M11)Normal Access	
0034E	14:16:24	Royal Hoyal	0004	Jack	1005	Dep_05	(M11)Normal Access	
0035E	18:42:21	Royal Hoyal	0004	Jack	1005	Dep_05	(M11)Normal Access	
0036E	18:42:22	Royal Hoyal	0003	San	1004	Dep_05	(M11)Normal Access	
0037E	18:42:23	Royal Hoyal	0005	Caven	1006	Dep_01	(M11)Normal Access	
0038E	18:42:24	Royal Hoyal	0002	David	1003	Dep_03	(M11)Normal Access	
0039E	18:42:25	Royal Hoyal	0001	Tom	1002	Dep_03	(M11)Normal Access	

After import the message of branch office

Default.pic TRANSACTION RECORDS20021001.msg

Press F1 for HELP

NUM 18:46:43

## 11. Change the picture that enter 701 Server



**The function: Put the logo of the company in the window of entering 701 Server.**

- ① Save company Logo to "server.bmp.file".
- ② Put server.bmp file into the path C:\Program Files\701 Server\
- ③ Re-login in 701 Server , you will find that company logo will be instead of default earth plan.

## 12. Remarks columns

**AR-716EV2/716Ei & 721H/727H System Setting Table**

Controller	Node ID: Master:																
On-line Readers	Node ID	1	2	3	4	5	6	7	8	9	10	11	12	13	14	15	16
	Door No.																
	Door Name																
Controller	Node ID: Master:																
On-line Readers	Node ID	1	2	3	4	5	6	7	8	9	10	11	12	13	14	15	16
	Door No.																
	Door Name																
Controller	Node ID: Master:																
On-line Readers	Node ID	1	2	3	4	5	6	7	8	9	10	11	12	13	14	15	16
	Door No.																
	Door Name																
Controller	Node ID: Master:																
On-line Readers	Node ID	1	2	3	4	5	6	7	8	9	10	11	12	13	14	15	16
	Door No.																
	Door Name																
Controller	Node ID: Master:																
On-line Readers	Node ID	1	2	3	4	5	6	7	8	9	10	11	12	13	14	15	16
	Door No.																
	Door Name																
Controller	Node ID: Master:																
On-line Readers	Node ID	1	2	3	4	5	6	7	8	9	10	11	12	13	14	15	16
	Door No.																
	Door Name																
Controller	Node ID: Master:																
On-line Readers	Node ID	1	2	3	4	5	6	7	8	9	10	11	12	13	14	15	16
	Door No.																
	Door Name																

**AR-829E / 821EF System Setting Table**

Node ID	Master	Door No.	Door Name
Node ID	Master	Door No.	Door Name
Node ID	Master	Door No.	Door Name
Node ID	Master	Door No.	Door Name



